

# BUGGY PROJECT

by: Paolo Franceschetti

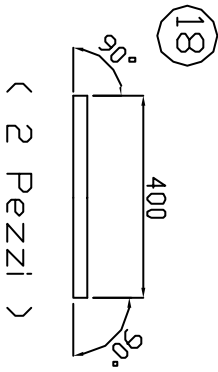

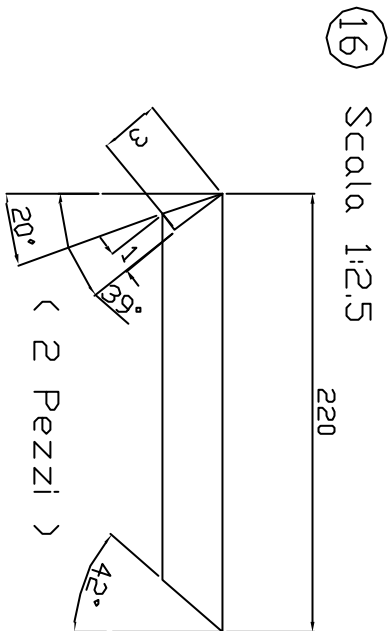

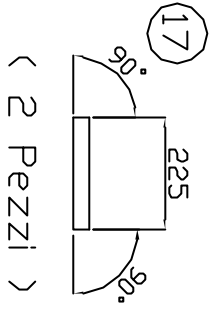
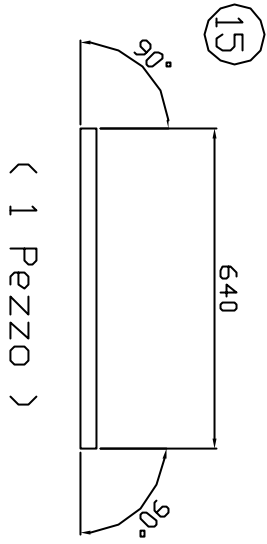

Misure espresse in mm.

Din. norma Tol. ISO 8015		Distribuito in Italia dal 20/08/03		Scale 1:10		Materiale Buggy		Size A3	
Nome		Nome FRANCOBILITATI		Data		Altezza Pezzi 7		Sheet	
Data		Nome Pezzi tecnologies		Nome				Z - 4	
Reference									

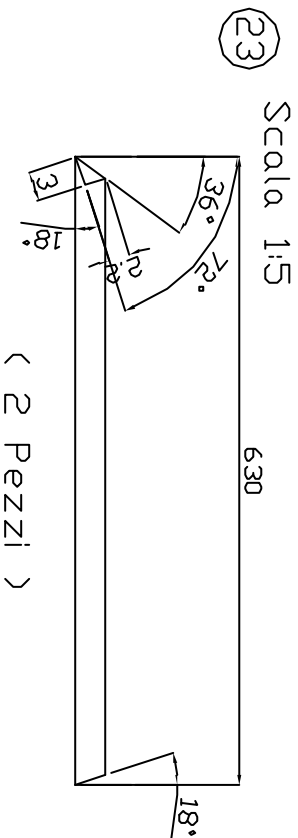
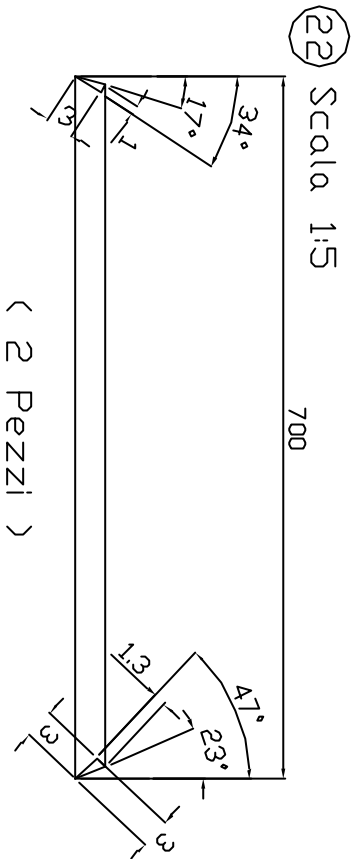
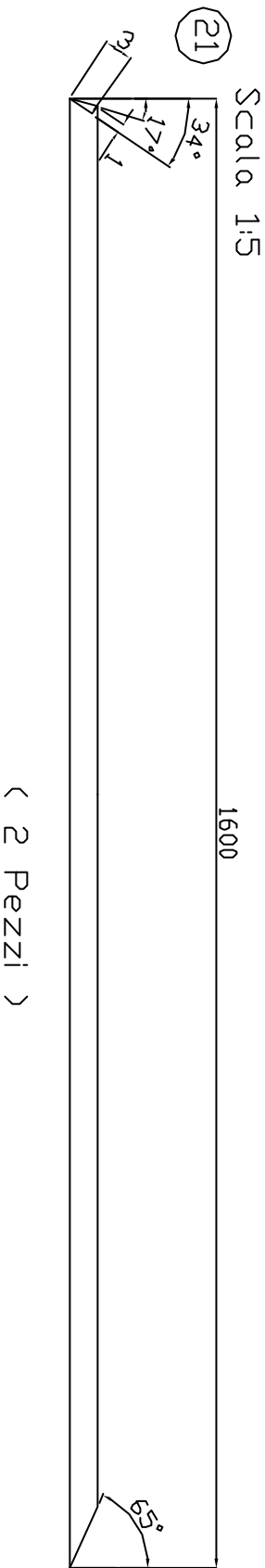
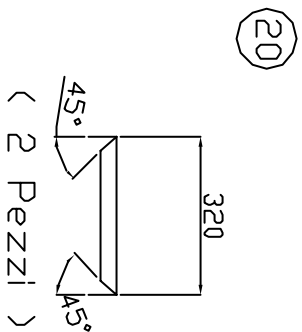
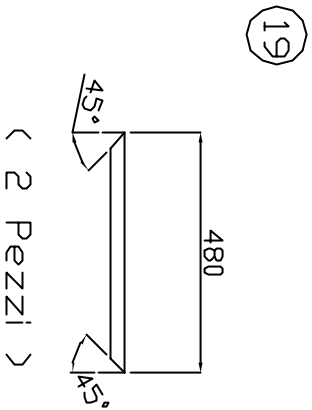

Misure espresse in mm.

Din. norma Tol. ISO 8015		Distribuiti in mm		Scala 1:10		Materiale		Size	
		Data 20/08/03				Buggy		A3	
		Nome FRANCESCO				Tetto Pezzi 10		Sheet	
Autore		Data		Nome				4 - 4	
Riferimenti				tecnologies					

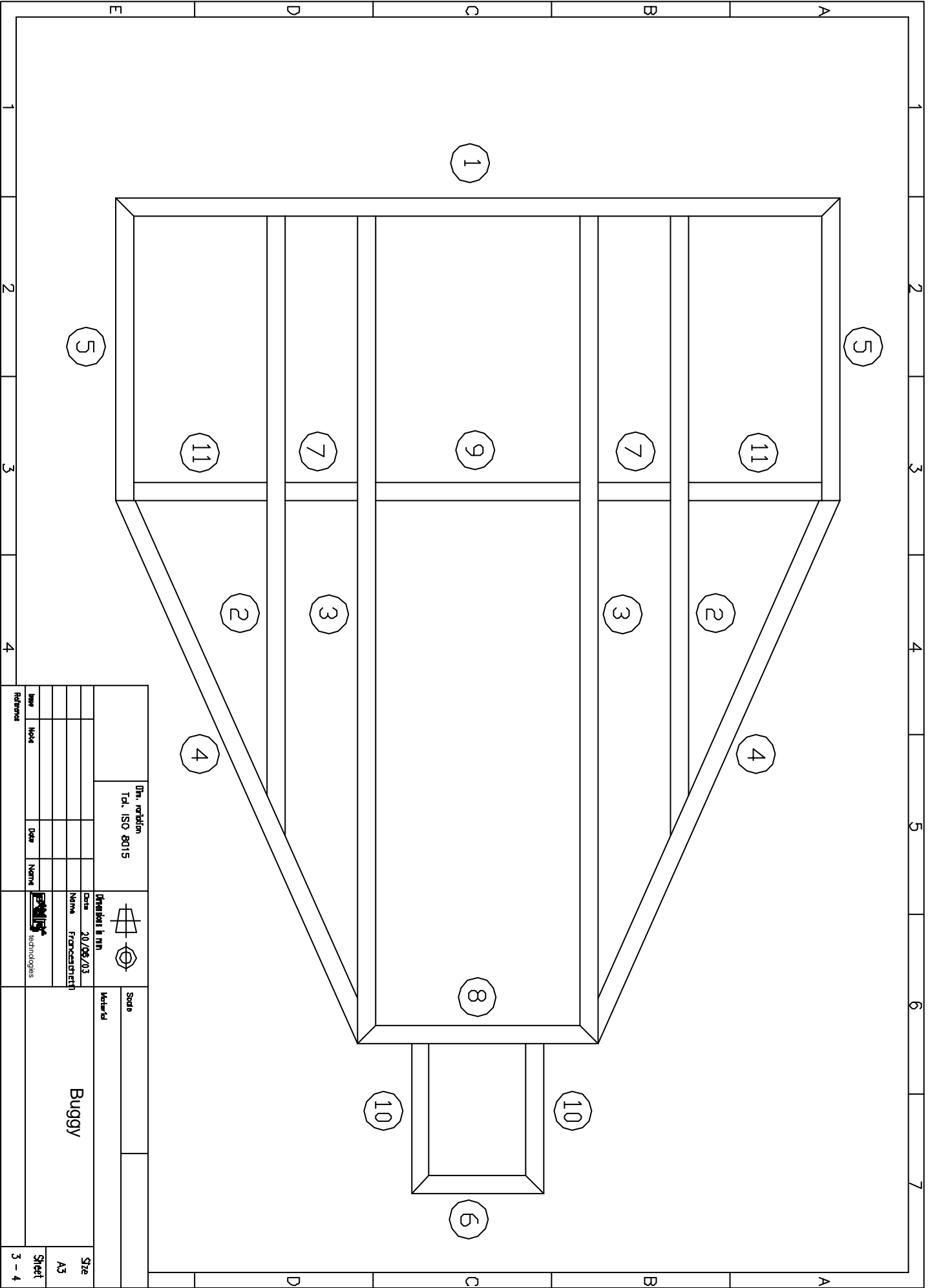

Din. notation Tol. ISO 8015			Distributeur le NIN		
Date 20/08/03			Nom FRANCISCHETTI		
Author	Role	Date	Name	References	
Scale			Material		
			Buggy		
Size A3		Sheet 3 - 4			

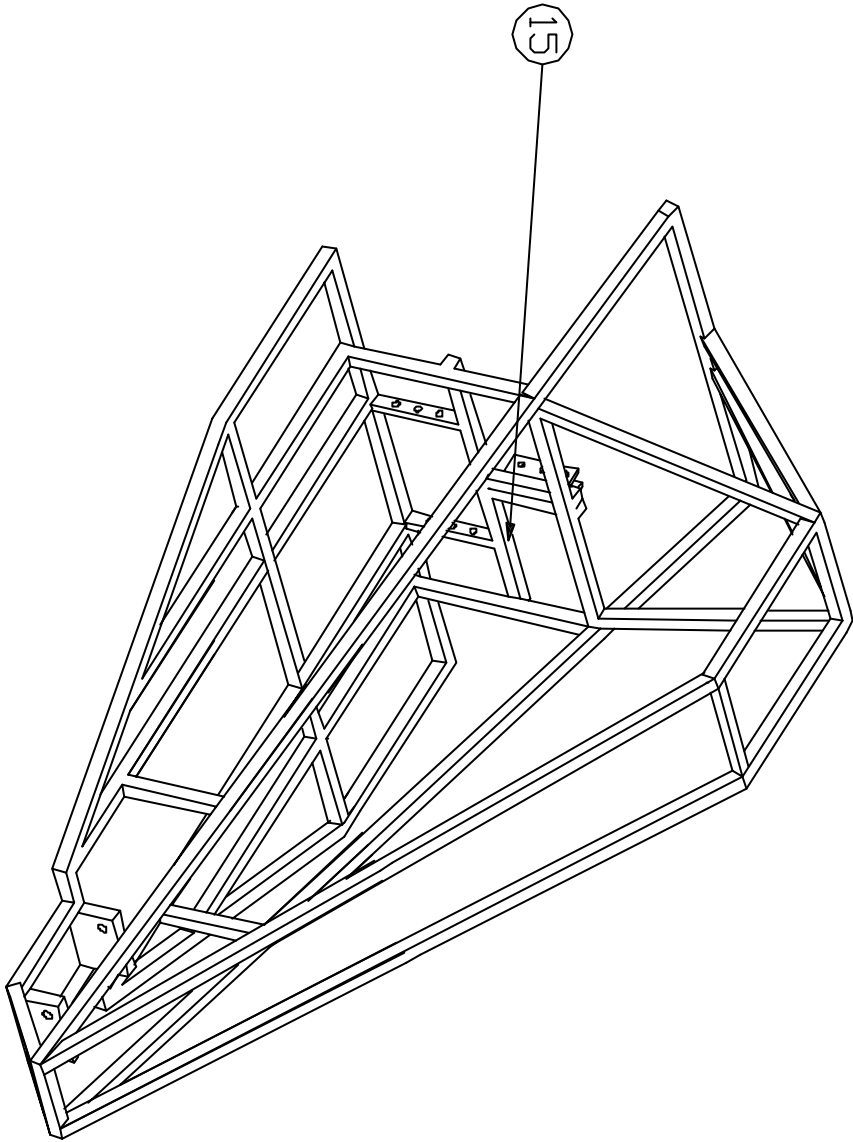

Din. notation Tol. ISO 8015		Distributeur le min.			Scale Material Buggy	Size A3
Date 20/08/03		Nomme FRANCISCHETTI				
Author	Notes	Date	Name	References		

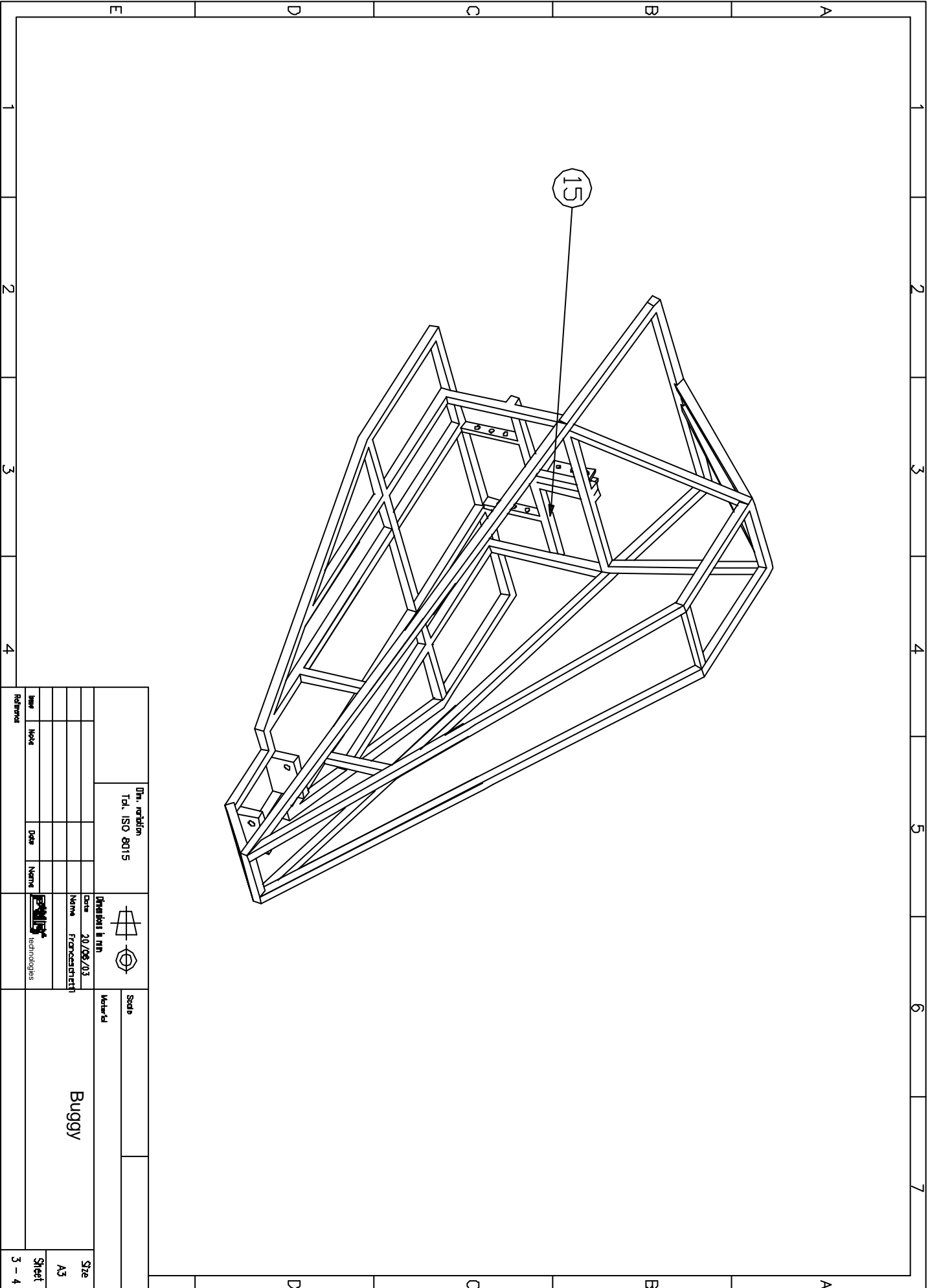

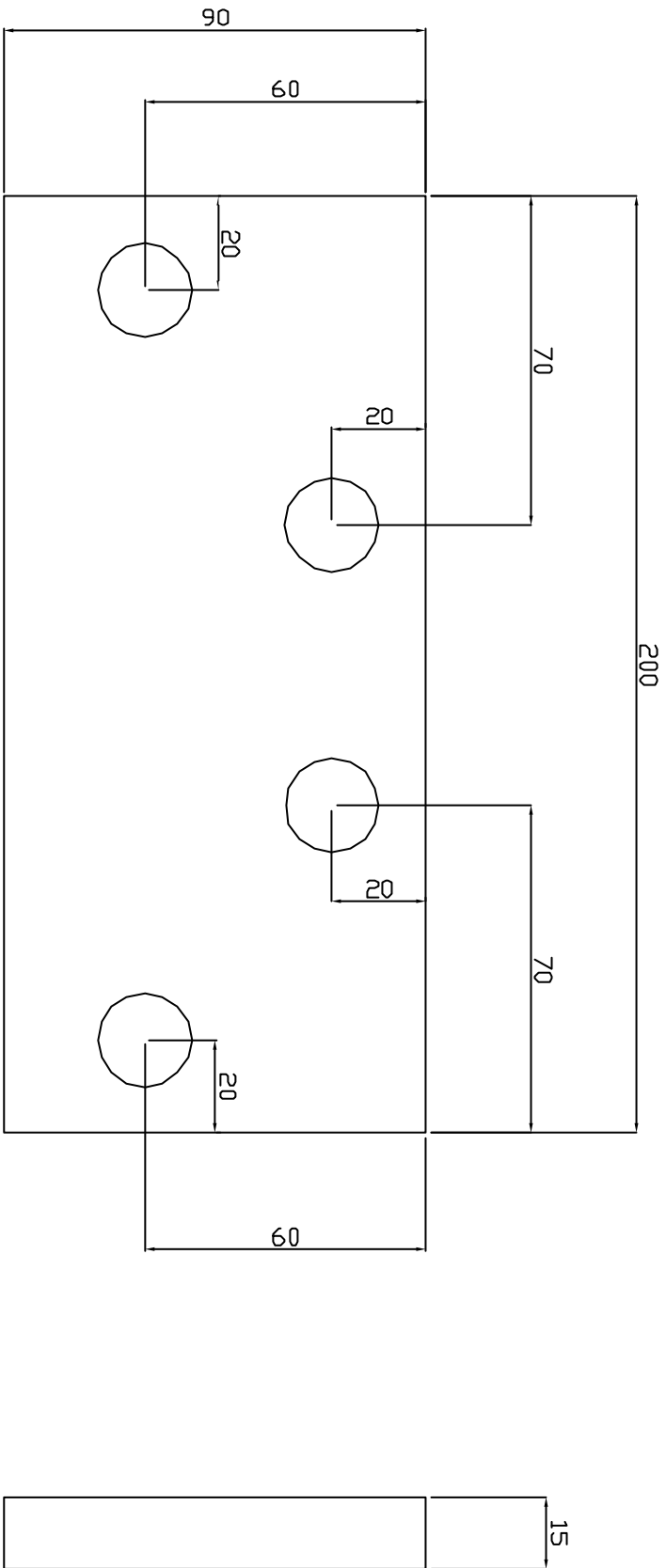

Scala 1:1

Misure espresse in mm.

Din. norma Tol. ISO 8015		Distribuito in mm		Scale		Material		Size	
		data 20/08/03		Buggy		porta braccetti anteriori		A3	
Nome		Nome		Nome		Nome		Sheet	
Data		Data		Data		Data		3 - 4	
Referenza		Referenza		Referenza		Referenza		3 - 4	

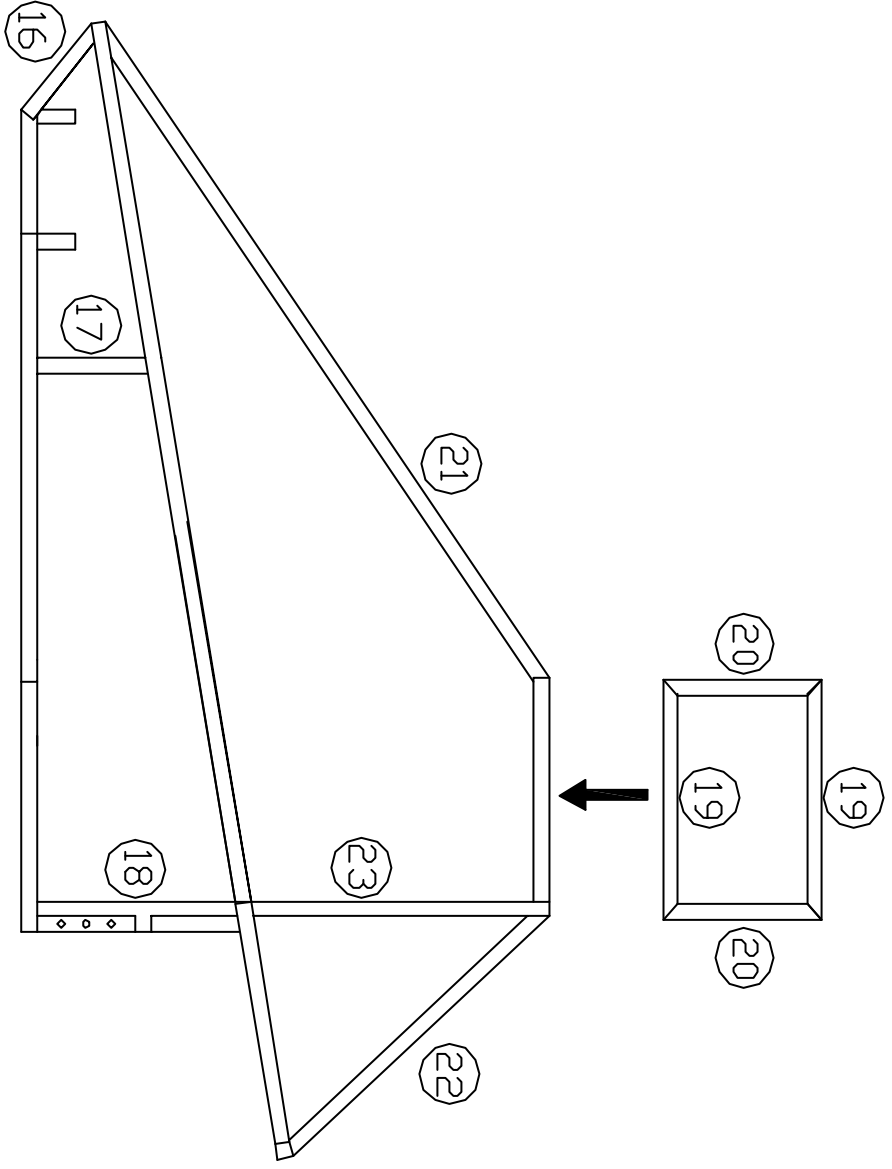
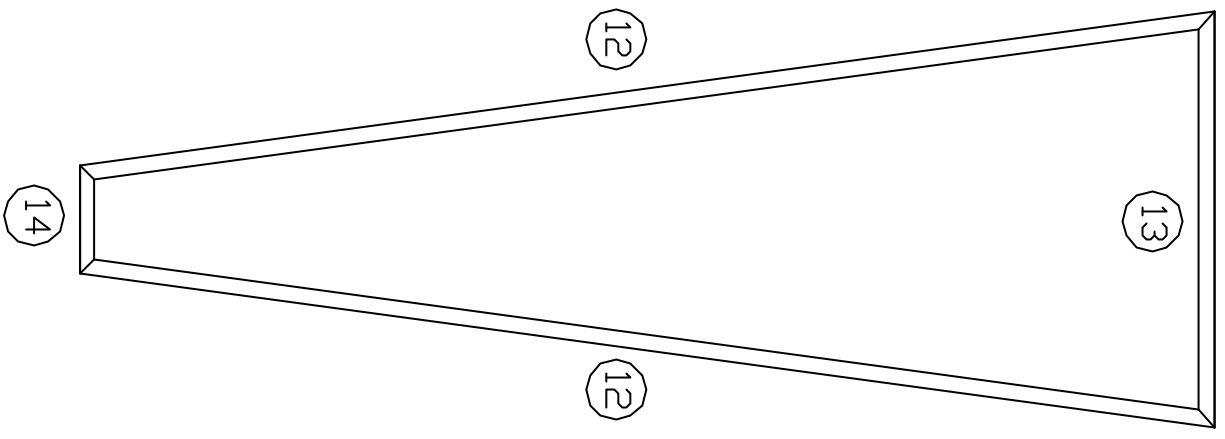

Din. notation Tol. ISO 8015		Distributeur le min. Date 20/08/03 Noms FRANCESTRETTI		Scale		Material		Size A3	
Author	Notes	Date	Name	Buggy		Sheet		3 - 4	
References		References		References		References		References	

Copying of this Document and giving it to others and the use or communication of the contents thereof, are forbidden without express authority. Offenders are liable to the payment of damages. All rights reserved in the event of the grant of a patent or the registration of a utility model or design.

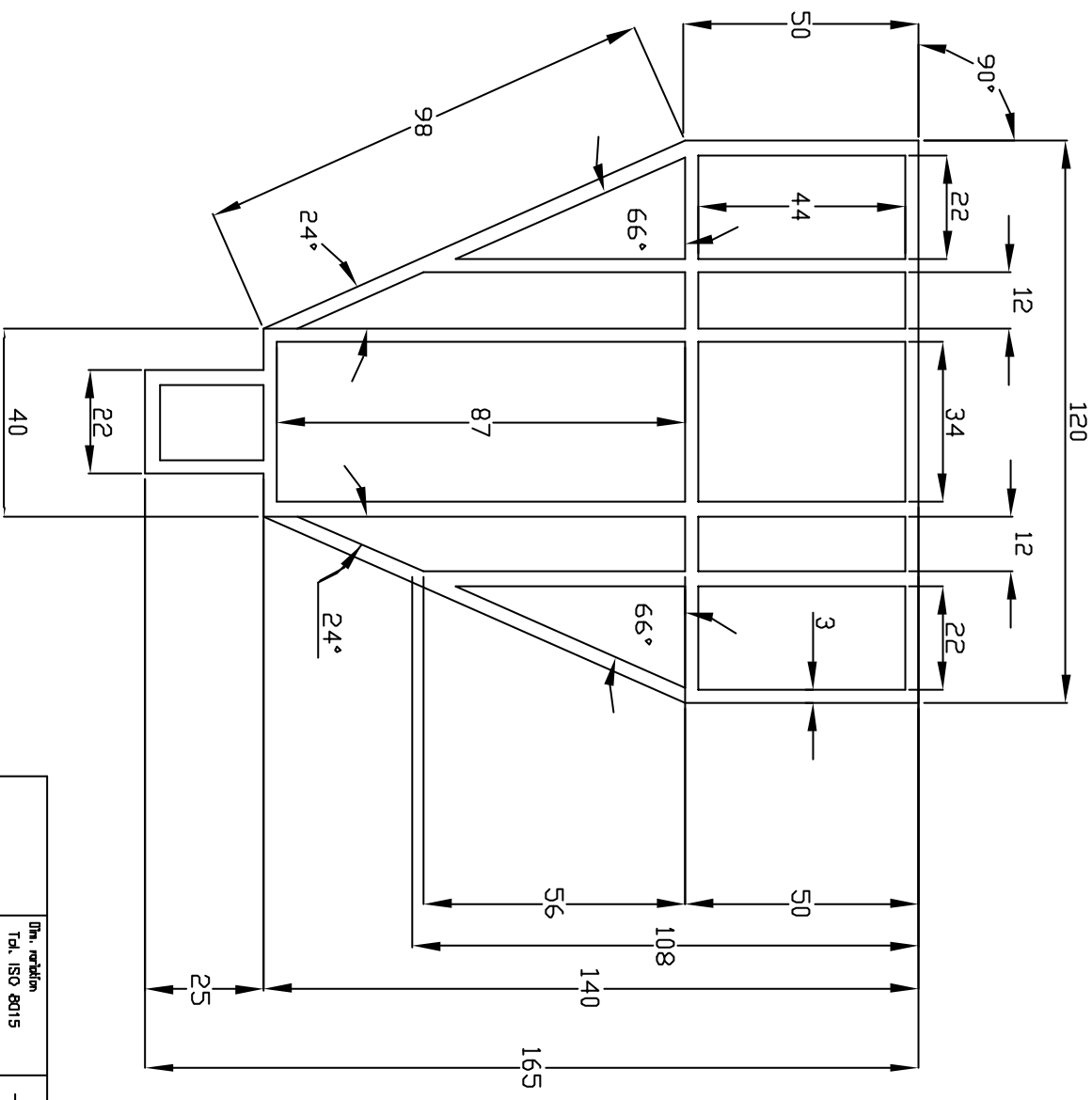

Din. notation Tol. ISO 8015		Distributeur le nom Date 20/08/03 Nomme FRANCECHIEFFI		Scale		Material		Size A3	
Impr	Notes	Date	Nomme	Buggy				Sheet 3 - 4	
References		Technologies							